

**SANYO**

No. ※4118

**LC7232N**

CMOS LSI  
**Single-chip PLL and Microcontroller  
 with LCD Driver**

Preliminary

**OVERVIEW**

The LC7232N is a single-chip microcontroller that incorporates a 0.5 to 150 MHz phase-locked loop (PLL) and a liquid-crystal display (LCD) driver, making it ideal for digital tuners. It incorporates frequency and period measurement circuits, and a large number of input/output ports on-chip.

The LC7232N comprises on-chip RAM and ROM, a programmable high-speed divider, a 6-bit analog-to-digital converter, two 8-bit digital-to-analog converters and a low-voltage detection reset circuit.

The LC7232N operates from a 5 V supply and is available in 80-pin QIPs.

**FEATURES**

- 0.5 to 150 MHz phase-locked loop
- LCD driver
- 6-bit analog-to-digital converter
- Two 8-bit PWM digital-to-analog converters
- Two 4-bit input/output ports
- Two 4-bit input ports
- One 4-bit output port
- 8-bit keypad matrix scan output port
- 4-bit open-drain, high-voltage output port
- 28 mask-selectable output drivers
- 20-bit universal counter
- 4096 × 16-bit program ROM (001H to FFFH user-addressable memory)
- 256 × 4-bit data RAM
- Low-voltage detection reset circuit
- Programmable high-speed divider
- Single-word instructions
- Four-level stack
- PLL-unlocked flip-flop
- Timer flip-flop
- External interrupt
- Programmable watchdog interrupt address
- Standby mode
- CPU operates down to 3.5 V and retains data down to 1.3 V.
- 5 V supply
- 80-pin QIP

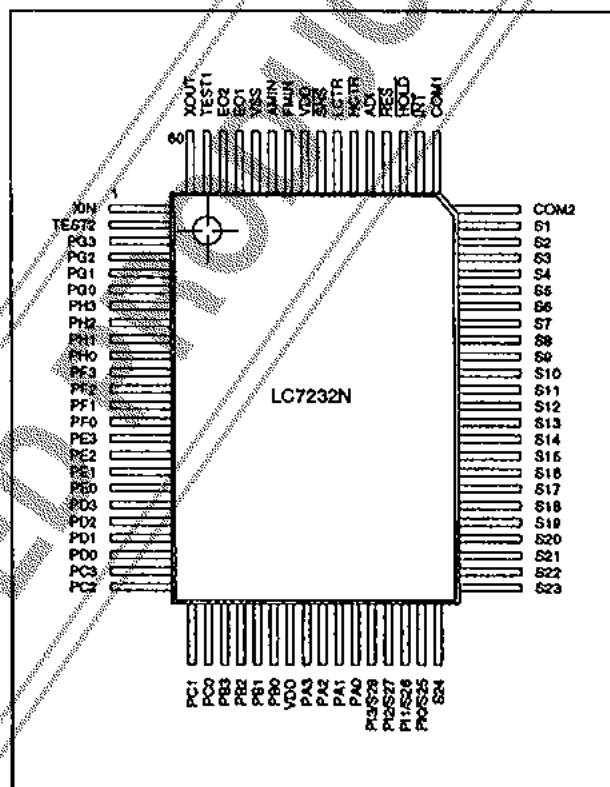
**PINOUT****PACKAGE DIMENSIONS**

Unit: mm

3044B-QIP80A

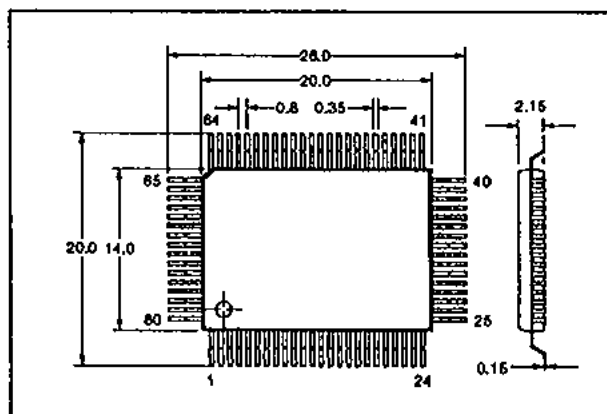

Specifications and information herein are subject to change without notice.

**SANYO Electric Co., Ltd. Semiconductor Division**  
 Natsume Bldg., 18-6, 2-chome, Yushima, Bunkyo-ku, TOKYO 113 JAPAN

3062JN No.4118-1/16

BLOCK DIAGRAM

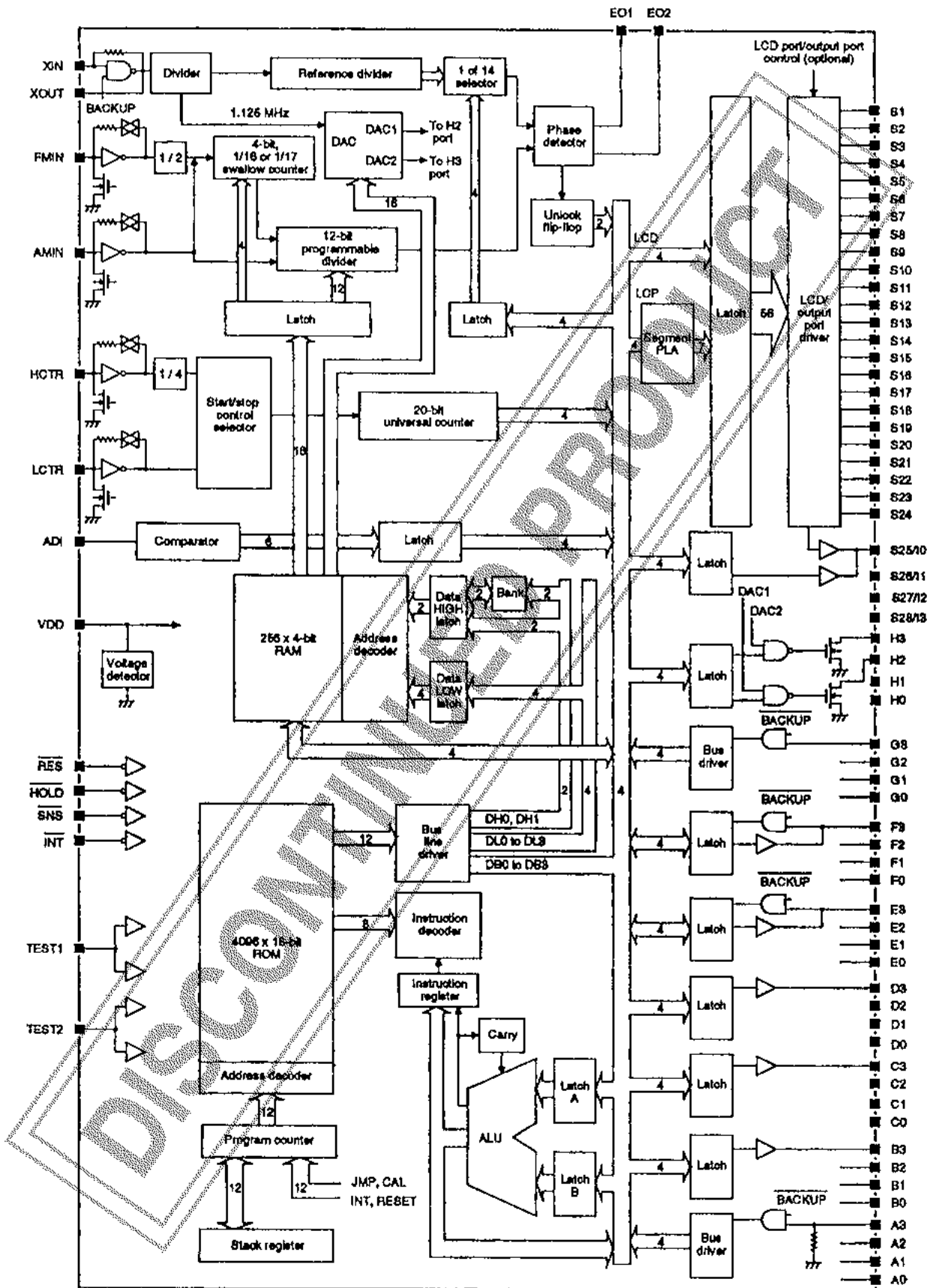

**PIN DESCRIPTION**

Number	Name	Equivalent Circuit	Description
1	XIN		Crystal oscillator connections
80	XOUT		
2	TEST2		Test pins
79	TEST1		
3 to 6	PG3 to PG0		Input port G
7 to 10	PH3 to PH0		Output port H
11 to 14	PF3 to PF0		Input/output port F
15 to 18	PE3 to PE0		Input/output port E
19 to 22	PD3 to PD0		Output port D
23 to 26	PC3 to PC0		Output port C
27 to 30	PB3 to PB0		Output port B
31, 79	VDD		5 V supply
32 to 35	PA3 to PA0		Input port A

LC7232N

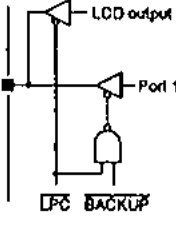
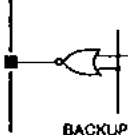
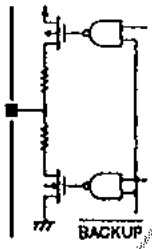
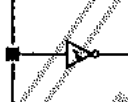
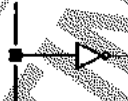
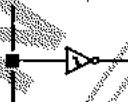
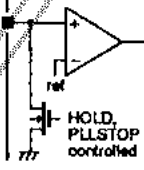
Number	Name	Equivalent Circuit	Description
36 to 39	PI3/S28 to PI0/S25		Input port 1
40 to 63	S24 to S1		LCD segment outputs
64, 65	COM2, COM1		LCD common driver outputs
66	$\overline{\text{INT}}$		Interrupt request input
67	$\overline{\text{HOLD}}$		Hold-mode control input
68	$\overline{\text{RES}}$		Device reset input
69	ADI		A/D converter input

## LC7232N

Number	Name	Equivalent Circuit	Description
70	HCTR		Universal counter input 1
71	LCTR		Universal counter input 2
72	$\overline{\text{SNS}}$		Power-fail detect
74	FMIN		FM VCO input
75	AMIN		AM VCO input
76	VSS		Ground
77, 78	EO1 and EO2		Phase comparator outputs

## SPECIFICATIONS

### Absolute Maximum Ratings

Parameter	Symbol	Rating	Unit
Supply voltage range	$V_{DD}$	-0.3 to 6.5	V
Port G, $\overline{\text{HOLD}}$ , $\overline{\text{ADL}}$ , $\overline{\text{INT}}$ , $\overline{\text{RES}}$ and $\overline{\text{SNS}}$ input voltage range	$V_{I1}$	-0.3 to 13	V
Input voltage range for all other inputs	$V_{I2}$	-0.3 to $V_{DD} + 0.3$	V
Port H output voltage range	$V_{O1}$	-0.3 to 16	V
Output voltage range for all other outputs	$V_{O2}$	-0.3 to $V_{DD} + 0.3$	V
Ports D and H output current range	$I_{O1}$	0 to 5	mA
Ports E and F output current range	$I_{O2}$	0 to 3	mA
Ports B and C output current range	$I_{O3}$	0 to 1	mA
Port I and S1 to S28 output current range	$I_{O4}$	0 to 1	mA
Power dissipation	$P_D$	400	mW

## LC7232N

Parameter	Symbol	Rating	Unit
Operating temperature range	$T_{op}$	-40 to 85	°C
Storage temperature range	$T_{stg}$	-45 to 125	°C

### Recommended Operating Conditions

$T_a = 25\text{ °C}$

Parameter	Symbol	Rating	Unit
Supply voltage	$V_{DD}$	5	V
Supply voltage range (PLL and CPU)	$V_{DD1}$	4.5 to 5.5	V
Supply voltage range (CPU)	$V_{DD2}$	3.5 to 5.5	V
Supply voltage range for data retention	$V_{DD3}$	1.3 to 5.5	V

### Electrical Characteristics

$V_{DD} = 3.5$  to  $5.5$  V,  $T_a = -40$  to  $85\text{ °C}$  unless otherwise noted

Parameter	Symbol	Condition	Rating			Unit
			min	typ	max	
Supply current	$I_{DD1}$	$f_i = 130$ MHz, $V_{DD} = 4.5$ to $5.5$ V	-	15	20	mA
Hold-mode supply current	$I_{DD2}$	PLL halted, $t_{osc} = 2.57\text{ }\mu\text{s}$ , $V_{DD} = 3.5$ to $5.5$ V	-	1.6	-	mA
		PLL halted, $t_{osc} = 15.33\text{ }\mu\text{s}$ , $V_{DD} = 3.5$ to $5.5$ V	-	1.0	-	
		PLL halted, $t_{osc} = 40.00\text{ }\mu\text{s}$ , $V_{DD} = 3.5$ to $5.5$ V	-	0.7	-	
Standby-mode supply current	$I_{DD3}$	$V_{DD} = 5.5$ V, oscillator halted, $T_a = 25\text{ °C}$	-	-	6	$\mu\text{A}$
		$V_{DD} = 2.5$ V, oscillator halted, $T_a = 25\text{ °C}$	-	-	1	
Port A LOW-level input voltage	$V_{IL1}$		0	-	$0.2V_{DD}$	V
Ports E and F LOW-level input voltage	$V_{IL2}$		0	-	$0.3V_{DD}$	V
Port G LOW-level input voltage	$V_{IL3}$		0	-	$0.3V_{DD}$	V
HOLD LOW-level input voltage	$V_{IL4}$		0	-	$0.4V_{DD}$	V
LCTR LOW-level input voltage	$V_{IL5}$	$V_{DD} = 4.5$ to $5.5$ V	0	-	$0.2V_{DD}$	V
RES and INT LOW-level input voltage	$V_{IL6}$		0	-	$0.2V_{DD}$	V
SRS LOW-level input voltage	$V_{IL7}$		0	-	1.3	V
Port A HIGH-level input voltage	$V_{IH1}$		$0.6V_{DD}$	-	$V_{DD}$	V
Ports E and F HIGH-level input voltage	$V_{IH2}$		$0.7V_{DD}$	-	$V_{DD}$	V
Port G HIGH-level input voltage	$V_{IH3}$		$0.7V_{DD}$	-	8.0	V
LCTR HIGH-level input voltage	$V_{IH4}$	$V_{DD} = 4.5$ to $5.5$ V	$0.8V_{DD}$	-	$V_{DD}$	V
RES, INT and HOLD HIGH-level input voltage	$V_{IH5}$		$0.8V_{DD}$	-	8.0	V

LC7232N

Parameter	Symbol	Condition	Rating			Unit
			min	typ	max	
SNS HIGH-level input voltage	$V_{IH6}$		2.5	–	8.0	V
XIN rms input amplitude	$V_{I1}$		0.5	–	1.5	V
FMIN rms input amplitude	$V_{I2}$		0.1	–	1.5	V
AMIN rms input amplitude	$V_{I3}$		0.1	–	1.5	V
LCTR and HCTR rms input amplitude	$V_{I4}$		0.1	–	1.5	V
ADI input voltage	$V_{I5}$		0	–	$V_{DD}$	V
LCTR, RES and INT input hysteresis width	$V_{HYS}$		$0.1V_{DD}$	–	–	V
Standby threshold voltage	$V_{DET}$		2.7	3.0	3.3	V
Port A input voltage	$V_{IF}$	Port A is high impedance. Port A has $R_{PP}$ .	–	–	$0.05V_{DD}$	V
XIN input frequency	$f_{I1}$	$V_I = 0.5$ to $1.5$ V	4.0	4.5	5.0	MHz
FMIN input frequency	$f_{I2}$	$V_I = 0.1$ to $1.5$ V, $V_{DD} = 4.5$ to $5.5$ V	10	–	130	MHz
		$V_I = 0.15$ to $1.5$ V, $V_{DD} = 4.5$ to $5.5$ V	10	–	160	
AMIN input frequency (low range)	$f_{I3}$	$V_I = 0.1$ to $1.5$ V, $V_{DD} = 4.5$ to $5.5$ V	0.5	–	10.0	MHz
AMIN input frequency (high range)	$f_{I4}$	$V_I = 0.1$ to $1.5$ V, $V_{DD} = 4.5$ to $5.5$ V	2	–	40	MHz
HCTR input frequency	$f_{I5}$	$V_I = 0.1$ to $1.5$ V, $V_{DD} = 4.5$ to $5.5$ V	0.4	–	120	MHz
LCTR input frequency	$f_{I6}$	$V_I = 0.1$ to $1.5$ V, $V_{DD} = 4.5$ to $5.5$ V	100	–	500	kHz
		$V_{I1} = 0$ V to $0.2V_{DD}$ $V_{I2} = 0.8V_{DD}$ to $V_{DD}$	0.001	–	20	
SNS reject pulsewidth	$P_{RE}$		–	–	50	$\mu$ s
Ports A, E and F LOW-level input current	$I_{IL1}$	Ports E and F are high impedance. Port A has no $R_{PP}$ . $V_I = V_{SS}$	–	–	3.0	$\mu$ A
INT, RES, HOLD, ADI, SNS and port G LOW-level input current	$I_{IL2}$	$V_I = V_{SS}$	–	–	3.0	$\mu$ A
LCTR, FMIN, AMIN and HCTR LOW-level input current	$I_{IL3}$	$V_I = V_{SS}$	4	10	30	$\mu$ A
XIN LOW-level input current	$I_{IL4}$	$V_I = V_{SS}$	2	5	15	$\mu$ A
Ports A, E and F HIGH-level input current	$I_{IH1}$	Ports E and F are high impedance. Port A has no $R_{PP}$ . $V_I = V_{DD}$	–	–	3.0	$\mu$ A
Port A HIGH-level input current	$I_{IH2}$	$V_I = V_{DD} = 5.0$ V. Port A has $R_{PP}$ .	–	50	–	$\mu$ A
INT, RES, HOLD, ADI, SNS and port G HIGH-level input current	$I_{IH3}$	$V_{IH} = 5.5$ V	–	–	3.0	$\mu$ A
LCTR, FMIN, AMIN and HCTR HIGH-level input current	$I_{IH4}$	$V_I = V_{DD} = 5.0$ V	4	10	30	$\mu$ A
XIN HIGH-level input current	$I_{IH5}$	$V_I = V_{DD} = 5.0$ V	2	5	15	$\mu$ A
Ports B and C LOW-level output voltage	$V_{OL1}$	$I_O = 50$ $\mu$ A	0.5	1.0	2.0	V

LC7232N

Parameter	Symbol	Condition	Rating			Unit
			min	typ	max	
Port D LOW-level output voltage	$V_{OL2}$	$I_O = 5 \text{ mA}$	-	-	1.0	V
Ports E and F LOW-level output voltage	$V_{OL3}$	$I_O = 1 \text{ mA}$	-	-	1.0	V
Port H LOW-level output voltage	$V_{OL4}$	$I_O = 5 \text{ mA}$	0.76 (150 $\Omega$ )	-	2.0 (400 $\Omega$ )	V
COM1 and COM2 LOW-level output voltage	$V_{OL6}$	$I_O = 25 \mu\text{A}$	0.3	0.5	0.75	V
EO1 and EO2 LOW-level output voltage	$V_{OL6}$	$I_O = 500 \mu\text{A}$	-	-	1.0	V
Port I and S1 to S28 LOW-level output voltage	$V_{OL7}$	$I_O = 0.1 \text{ mA}$	-	-	1.0	V
XOUT LOW-level output voltage	$V_{OL8}$	$I_O = 200 \mu\text{A}$	-	-	1.0	V
COM1 and COM2 mid-level output voltage	$V_{M1}$	$V_{DD} = 6 \text{ V}, I_O = 20 \mu\text{A}$	2.0	2.5	3.0	V
Ports B and C HIGH-level output voltage	$V_{OH1}$	$I_O = 1 \text{ mA}$	$V_{DD} - 2.0$	$V_{DD} - 1.0$	$V_{DD} - 0.5$	V
Port D HIGH-level output voltage	$V_{OH2}$	$I_O = 5 \text{ mA}$	$V_{DD} - 1.0$	-	-	V
Ports E and F HIGH-level output voltage	$V_{OH3}$	$I_O = 1 \text{ mA}$	$V_{DD} - 1.0$	-	-	V
COM1 and COM2 HIGH-level output voltage	$V_{OH4}$	$I_O = 25 \mu\text{A}$	$V_{DD} - 0.75$	$V_{DD} - 0.5$	$V_{DD} - 0.3$	V
EO1 and EO2 HIGH-level output voltage	$V_{OH5}$	$I_O = 500 \mu\text{A}$	$V_{DD} - 1.0$	-	-	V
Port I and S1 to S28 HIGH-level output voltage	$V_{OH6}$	$I_O = -0.1 \text{ mA}$	$V_{DD} - 1.0$	-	-	V
XOUT HIGH-level output voltage	$V_{OH7}$	$I_O = 200 \mu\text{A}$	$V_{DD} - 1.0$	-	-	V
Ports B, C, E, F and I LOW-level output leakage current	$I_{OFFL1}$	$V_O = V_{SS}$	-	-	3.0	$\mu\text{A}$
EO1 and EO2 LOW-level output leakage current	$I_{OFFL2}$	$V_O = V_{SS}$	-	0.01	10.0	nA
Ports B, C, E, F and I HIGH-level output leakage current	$I_{OFFH1}$	$V_O = V_{DD}$	-	-	3.0	$\mu\text{A}$
Port H HIGH-level output leakage current	$I_{OFFH2}$	$V_O = 13 \text{ V}$	-	-	5.0	$\mu\text{A}$
EO1 and EO2 HIGH-level output leakage current	$I_{OFFH3}$	$V_O = V_{DD}$	-	0.01	10.0	nA
A/D converter error	$\epsilon$	$V_{DD} = 4.5 \text{ to } 5.5 \text{ V}$	$-\frac{1}{2}$	-	$\frac{1}{2}$	lsb
Port A pull-down resistance	$R_{PD}$	$V_{DD} = 5 \text{ V}$	75	100	200	k $\Omega$



Measurement Circuits

Hold mode

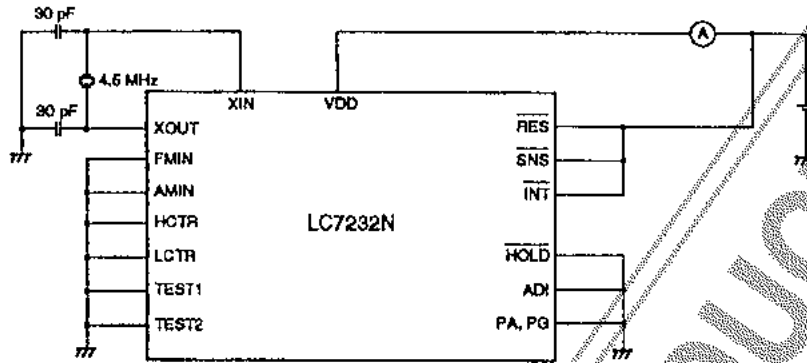

Notes

1. Ports E and F are selected as output ports.
2. Ports B to H are open.

Standby mode

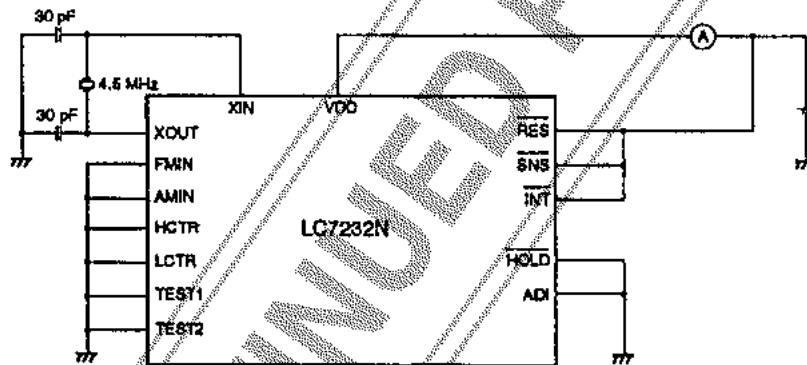

Note

Ports A to I, S1 to S24, COM1 and COM2 are open.

FUNCTIONAL DESCRIPTION

LCD Driver

The LC7232N can drive LCD segments. The LCP and LCD instructions transfer data to the LCD outputs. The LCD instruction transfers data directly to the LCD outputs whereas the LCP instruction converts data to 7-segment format before transfer to the outputs.

S1 to S28 are the driver outputs. The LCD frame rate is 100 Hz with a 50% duty cycle. After reset or power-up, a blank signal is present on all outputs. In standby mode, all outputs are LOW. They can be used as general-purpose outputs if the appropriate mask option is selected.

COM1 and COM2 are the LCD common driver outputs. Output drive is 50% duty with 50% bias. Upon reset or after power-up, the normal drive signals are present on these outputs. In standby mode, all outputs are LOW.

Frequency and Period Measurement

AM IF frequencies are measured at HCTR and LCTR by the 20-bit universal counter using an input frequency range of 0.4 to 12 MHz. FM IF frequencies are measured at HCTR only. Capacitive coupling should be used at HCTR for all input frequencies, and at LCTR, for input frequencies in the range 100 to 500 KHz.

Period measurement is performed at LCTR by the 20-bit universal counter using an input frequency range of 1 Hz to 20 KHz. Capacitive coupling is not required.

Phase-locked Loop

The FMIN or AMIN input signal is divided down by a programmable divider, and then compared with the crystal frequency, which is also divided down using 14

selectable ratios. The phase difference between the two signals is measured using a phase detector and output on EO1 and EO2.

FMIN is the input pin for the FM VCO input signal. The input frequency range is 10 to 130 MHz. Capacitive coupling should be used.

AMIN is the AM VCO input. The bandwidth is adjustable in two ranges by using the PLL instruction—HIGH (2 to 40 MHz) for the SW band, and LOW (0.5 to 10 MHz), for the LW and MW bands. Capacitive coupling should be used.

## Input/Output Ports

### Port A

This input port has a low switching threshold, which is used for keypad matrix inputs. Pull-down resistors for all pins are available as a mask option. Note that either all or none of the pins should have pull-down resistors. In standby mode, inputs are ignored.

### Ports B and C

These output ports have unbalanced CMOS outputs which are used as keypad matrix scan outputs. Upon reset, outputs are set LOW, and in standby mode, outputs are high impedance. The outputs can be short-circuited.

### Port D

Port D is an output port only. Upon reset, outputs are LOW, and in standby mode, outputs are high impedance.

### Port E

The transfer direction of this input/output port is selected automatically under software control. When an input instruction (IN, TPT, or TPF) is executed, port E is configured for input operation, and an output instruction (OUT, SPB or RPB) for output operation. Upon reset, all pins become inputs. In standby mode, the output drivers are high impedance and the input signals are ignored. All bits should either be inputs or outputs.

### Port F

The transfer direction of this input/output port is selected by the FPC instruction. Each pin of this port can be set independently to be an input or output. Upon reset, all pins become inputs. In standby mode, the output drivers are high impedance and the input signals are ignored.

### Port G

This is an input port only. In standby mode, inputs are ignored.

### Port H

These output ports are high-voltage, n-channel open-drain drivers, which are used for switching power supplies. Upon reset and in standby mode, outputs are high impedance.

### Port I

Port I is a 4-bit general purpose output port. The outputs PI0 to PI3 are multiplexed with four of the LCD driver outputs, S25 to S28. The bits can be configured as either standard outputs or LCD driver outputs by using the SS and RS instructions. Upon power-on or after reset, they are configured as LCD drivers and output a blank display signal. In standby mode these pins are LOW.

## A/D Converter

The A/D converter is a 6-bit successive approximation type. The conversion cycle time is 1.28 ms. Full-scale output data is 3FH for an input of  $(63/96) \times V_{DD}$ .

## PWM Outputs

Bits 2 and 3 of port H are the outputs of DAC1 and DAC2, respectively. The outputs are pulsewidth modulation (PWM) encoded, with the width of the output pulse determined by the value loaded into the 8-bit register for the corresponding DAC. The output frequency is 4394.5 Hz for a cycle time of 2.67  $\mu$ s.

## Power-fail Detection

When connected to the supply, SNS is used as a power-fail detector. SNS can also be used as a standard input port.

## Interrupt Request

This input generates a device interrupt when a HIGH-to-LOW transition occurs. The corresponding INTEN flag should be set by the SS instruction before an interrupt can be generated.

## Reset

This input can be used to re-initialize the LC7232N. Upon power-up, this pin should be held LOW for at least 75 ms after the supply stabilizes. Thereafter, it should be held LOW for at least six clock cycles to reset the device.

## Crystal Oscillator

The master crystal oscillator, which has a feedback resistor on-chip, requires only the connection of a 4.5 MHz crystal.

## Low-power Modes

### Hold mode

When the hold mode control pin,  $\overline{\text{HOLD}}$ , is driven LOW and the HOLDEN (hold enable) flip-flop has previously been set by an SS instruction, the LC7232N enters hold mode.

$\overline{\text{HOLD}}$  has a high-voltage input ( $V_{\text{H}}(\text{max}) = 8.0 \text{ V}$ ) which can be connected directly to the power supply.

### Standby mode

When the LC7232N is in hold mode and  $\overline{\text{HOLD}}$  is LOW, standby mode can be set by the CKSTP instruction.

### Test Pins

Two device test pins are provided—TEST1 and TEST2. These should either be tied to  $V_{\text{SS}}$  or left open.

## INSTRUCTION SET

ADDR	Program memory address [12 bits]
b	Borrow
B	Bank number [2 bits]
C	Carry
DH	Data memory address high-order bits (row address) [2 bits]
DL	Data memory address low-order bits (column address) [4 bits]
I	Immediate data [4 bits]
M	Data memory address
N	Bit position [4 bits]
$P_n$	Port number [4 bits]
r	General register (Bank 0 addresses 00H to 0FH)
$R_n$	Register number [4 bits]
( )	Contents of register or memory
( ) $_n$	Contents of bit N of register or memory

DISCONTINUED PRODUCT

Mnemonic	Operand		Operation	Instruction format																Description	Skip condition
	1st	2nd		D15	D14	D13	D12	D11	D10	D9	D8	D7	D6	D5	D4	D3	D2	D1	D0		
	Add																				
AD	r	M	Add M to r.	0	1	0	0	0	0	0	0	0	0	0	0	0	0	Rn	$r \leftarrow (r) + (M)$	Adds the contents of M to the contents of r and stores the result in r.	
ADS	r	M	Add M to r and skip if carry.	0	1	0	0	0	0	0	0	0	0	0	0	0	0	Rn	$r \leftarrow (r) + (M)$ , skip if carry.	Adds the contents of M to the contents of r then stores the result in r. Skips if a carry is generated.	Carry
AC	r	M	Add M to r with carry.	0	1	0	0	0	0	0	0	0	0	0	0	0	0	Rn	$r \leftarrow (r) + (M) + C$	Adds the contents of M to the contents of r and C then stores the result in r.	
ACS	r	M	Add M to r with carry and skip if carry.	0	1	0	0	0	0	0	0	0	0	0	0	0	0	Rn	$r \leftarrow (r) + (M) + C$ , skip if carry.	Adds the contents of M to the contents of r and C then stores the result in r. Skips if a carry is generated.	Carry
AI	M	r	Add 1 to M.	0	1	0	0	0	0	0	0	0	0	0	0	0	r	$M \leftarrow (M) + 1$	Adds the immediate data to the contents of M then stores the result in M.		
AIS	M	r	Add 1 to M and skip if carry.	0	1	0	0	0	0	0	0	0	0	0	0	0	r	$M \leftarrow (M) + 1$ , skip if carry.	Adds the immediate data to the contents of M then stores the result in M. Skips if a carry is generated.	Carry	
AIC	M	r	Add 1 to M with carry.	0	1	0	0	0	0	0	0	0	0	0	0	0	r	$M \leftarrow (M) + 1 + C$	Adds the immediate data to the contents of M and C then stores the result in M.		
ACS	M	r	Add 1 to M with carry and skip if carry.	0	1	0	0	0	0	0	0	0	0	0	0	0	r	$M \leftarrow (M) + 1 + C$ , skip if carry.	Adds the immediate data to the contents of M and C then stores the result in M. Skips if a carry is generated.	Carry	
Subtract																					
SU	r	M	Subtract M from r.	0	1	1	0	0	0	0	0	0	0	0	0	0	0	Rn	$r \leftarrow (r) - (M)$ , skip if carry.	Subtracts the contents of M from the contents of r then stores the result in r.	
S/S	r	M	Subtract M from r and skip if borrow.	0	1	1	0	0	0	0	0	0	0	0	0	0	0	Rn	$r \leftarrow (r) - (M)$ , skip if borrow.	Subtracts the contents of M from the contents of r then stores the result in r. Skips if a borrow is generated.	Borrow
S8	r	M	Subtract M from r with borrow.	0	1	1	0	0	0	0	0	0	0	0	0	0	0	Rn	$r \leftarrow (r) - (M) - b$	Subtracts the contents of M from the contents of r with borrow then stores the result in r.	
S/S8	r	M	Subtract M from r with borrow and skip if borrow.	0	1	1	0	0	0	0	0	0	0	0	0	0	0	Rn	$r \leftarrow (r) - (M) - b$ , skip if borrow.	Subtracts the contents of M from the contents of r with borrow then stores the result in r. Skips if a borrow is generated.	Borrow
SI	M	r	Subtract 1 from M.	0	1	1	0	0	0	0	0	0	0	0	0	0	r	$M \leftarrow (M) - 1$	Subtracts the immediate data from the contents of M then stores the result in M.		
S/S	M	r	Subtract 1 from M and skip if borrow.	0	1	1	0	0	0	0	0	0	0	0	0	0	r	$M \leftarrow (M) - 1$ , skip if borrow.	Subtracts the immediate data from the contents of M then stores the result in M. Skips if a borrow is generated.	Borrow	
S/S8	M	r	Subtract 1 from M with borrow.	0	1	1	0	0	0	0	0	0	0	0	0	0	r	$M \leftarrow (M) - 1 - b$	Subtracts the immediate data from the contents of M with borrow then stores the result in M.		
S/S/S8	M	r	Subtract 1 from M with borrow and skip if borrow.	0	1	1	0	0	0	0	0	0	0	0	0	0	r	$M \leftarrow (M) - 1 - b$ , skip if borrow.	Subtracts the immediate data from the contents of M with borrow then stores the result in M. Skips if a borrow is generated.	Borrow	

Mnemonic	Operand		Instruction format																Description	Skip condition			
	1st	2nd	Operation	Compare																			
				D15	D14	D13	D12	D11	D10	D9	D8	D7	D6	D5	D4	D3	D2	D1			D0		
SEQ	r	M	Set if equals M	0	0	0	0	0	0	0	0	0	0	0	0	1	DH	DH	DL	DL	R0	Compares the contents of r and M then skips if they are equal.	(r) = (M)
SGE	r	M	Set if greater than or equal to M	0	0	0	0	0	0	0	0	0	0	0	0	1	DH	DH	DL	DL	R0	Compares the contents of r and M then skips if r is greater than or equal to M.	(r) ≥ (M)
SE0	M	1	Set if M equals 1	0	0	0	0	0	0	0	0	0	0	0	0	1	DH	DH	DL	DL	1	Compares the immediate data to the contents of M then skips if they are equal.	(M) = 1 = 0
SGE	M	1	Set if M is greater than or equal to 1	0	0	0	0	0	0	0	0	0	0	0	0	1	DH	DH	DL	DL	1	Compares the contents of M with the immediate data then skips if M is greater than or equal to 1.	(M) ≥ 1
Logic																							
AND	M	1	AND 1 with M.	0	0	0	0	0	0	0	0	0	0	0	0	0	DH	DH	DL	DL	1	Calculates the logical AND of the immediate data and the contents of M then stores the result in M.	M ← (M) & 1
OR	M	1	OR 1 with M.	0	0	0	0	0	0	0	0	0	0	0	0	1	DH	DH	DL	DL	1	Calculates the logical OR of the immediate data and the contents of M then stores the result in M.	M ← (M)   1
EXL	r	M	Exclusive-OR M with r.	0	0	0	0	0	0	0	0	0	0	0	0	0	DH	DH	DL	DL	R0	Calculates the logical Exclusive-OR of the contents of r and the contents of M then stores the result in r.	r ← (r) ⊕ (M)
Load and store																							
LD	r	M	Load M into r.	1	0	0	0	0	0	0	0	0	0	0	0	0	DH	DH	DL	DL	R0	Moves the contents of M to r.	r ← (M)
ST	M	r	Store r in M.	1	0	0	0	0	0	0	0	0	0	0	0	1	DH	DH	DL	DL	R0	Moves the contents of r to M.	M ← (r)
MVRD	r	M	Move M to M addressed by R0	1	0	0	0	0	0	0	0	0	0	0	0	1	DH	DH	DL	DL	R0	Moves the contents of M to the address referenced by R0.	(R0, R0) ← (M)
MVRS	M	r	Move M addressed by R0 to M.	1	0	0	0	0	0	0	0	0	0	0	0	1	DH	DH	DL	DL	R0	Moves the contents of the memory location referenced by R0 and R0 to M.	M ← (R0, R0)
MVSR	M1	M2	Move M1 to M2.	1	0	0	0	0	0	0	0	0	0	0	0	0	DH	DH	DL1	DL2	DL2	Moves the contents of memory location 1 to memory location 2.	(R0, DL1) ← (R0, DL2)
MAN	M	1	Move 1 to M.	1	0	0	0	0	0	0	0	0	0	0	0	1	DH	DH	DL	DL	1	Moves the immediate data to M.	M ← 1
PULL	M	r	Load M to PULL registers.	1	0	0	0	0	0	0	0	0	0	0	0	0	DH	DH	DL	DL	R0	Moves the contents of M to the PULL registers.	PULL ← (M)
Bit test																							
TMT	M	N	Test bits of M and skip if true.	1	0	0	0	0	0	0	0	0	0	0	0	0	DH	DH	DL	DL	K	Tests the bits of memory location M specified by N. Skips if all bits are logic 1.	All bits specified = 1
TMF	M	N	Test bits of M and skip if false.	1	0	0	0	0	0	0	0	0	0	0	0	1	DH	DH	DL	DL	K	Tests the bits of memory location M specified by N. Skips if all bits are logic 0.	All bits specified = 0

Mnemonic	Operand		Operation	Instruction format																Notation	Description	Skip condition
	16	24		D15	D14	D13	D12	D11	D10	D9	D8	D7	D6	D5	D4	D3	D2	D1	D0			
Jump and subroutines																						
JMP	ADDR		Jump to address.	1	0	1	1	ADDR (12 bits)										PC ← ADDR	Jumps to the address specified by ADDR.			
CAL	ADDR		Call subroutine.	1	1	0	0	ADDR (12 bits)										Stack ← (PC + 1); PC ← ADDR	Jumps to the subroutine specified by ADDR.			
RT			Return from subroutine.	1	1	0	1											PC ← stack	Returns from a subroutine.			
RTI			Return from interrupt.	1	1	0	1											PC ← stack	Returns from an interrupt.			
Flag test																						
TLU	N		Test lower bit-lop.	1	1	0	1											Skip if lower FF = 0	Tests the lower bit-lop and skips if zero.	Timer FF = 0		
TUL	N		Test PLL bit-lop.	1	1	0	1											Skip if PLL FF = 0	Tests the PLL-unlocked bit-lop and skips if zero.	PLL FF = 0		
Status register bits and set																						
SS	N		Set status register bit.	1	1	0	1											(Status register 1) N ← 1	Sets the bit of status register 1 specified by N.			
RS	N		Reset status register bit.	1	1	0	1											(Status register 1) N ← 0	Resets the bit of status register 1 specified by N.			
TST	N		Test status register bits and skip if bit.	1	1	0	1											Skip if (status register 2) N = all 1	Tests the bits of status register 2. Skips if all bits are 1.	All bits specified = 1		
TSF	N		Test status register bits and skip if bit.	1	1	0	1											Skip if (status register 2) N = all 0	Tests the bits of status register 2. Skips if all bits are 0.	All bits specified = 0		
Stack select																						
BANK	B		Select bank.	1	1	0	1											STATUS ← 0	Selects one of four memory banks.			
Input/output																						
LCD	M	I	Move data to LCD segment.	1	1	1	0	DH		DL		DOUT						LCD (DOUT) ← I	Loads the immediate data directly to the LCD driver.			
LCP	M	I	Move 7-segment data to LCD.	1	1	1	0	DH		DL		DOUT						LCD (DOUT) ← PUA ← I	Converts the immediate data to 7-segment format using a PLA then transfers it to the LCD driver.			
IN	M	Pa	Move port data to M.	1	1	1	0	DH		DL		P						M ← (port Pn)	Moves the data from I/O port Pn to M.			
OUT	M	Pn	Move data to port.	1	1	1	0	DH		DL		P						(Port Pn) ← M	Moves the contents of memory location M to port Pn.			
SPB	Ph	N	Set port bits.	1	1	1	0	0		0		N ← 1						(Port Pn) N ← 1	Sets the bit of port Pn specified by N to logic 1.			
SPR	Ph	N	Reset port bits.	1	1	1	0	0		0		N ← 0						(Port Pn) N ← 0	Sets the bit of port Pn specified by N to logic 0.			

Mnemonic	Operand		Instruction format																Mnemonic	Description	Mnemonic	Step condition
	1st	2nd	D15	D14	D13	D12	D11	D10	D9	D8	D7	D6	D5	D4	D3	D2	D1	D0				
TPT	Pn	N	1	1	1	1	0	1	0	1	0		P			N			Step if (port Pn) N = all 1	Test the bits of port Pn specified by N. Steps if all bits are logic 1.		All bits specified = 1
TPF	Pa	N	1	1	1	1	1	1	1	1	1		P			N			Step if (port Pn) N = all 0	Test the bits of port Pn specified by N. Steps if all bits are logic 0.		All bits specified = 0
Universal counter																						
UCS	1		0	0	0	0	0	0	0	1	0	0	0	0	0	1			UCCW1 ← 1	Set the universal counter Reg 1.		
UCC	1		0	0	0	0	0	0	0	1	1	0	0	0	0	1			UCCW2 ← 1	Set the universal counter Reg 2.		
Miscellaneous																						
FPC	N		0	0	0	0	0	0	0	0	0	0	0	0	0	N			FPC latch ← N	Defines the direction of individual pins of port F. If a bit in the port F direction register is set by FPC, the corresponding pin of port F becomes an output.		
CRSTP			0	0	0	1	0	0	0	0	1	0	0	0	0	0	0	0	Step clear if HOLD = 0	Steps the processor clock if HOLD = 0.		
DAC	1		0	0	0	0	0	0	0	1	0	0	0	0	0	1			DAC ← 1	Loads the immediate data to the DAC registers.		
NOP			0	0	0	0	0	0	0	0	0	0	0	0	0				No operation	No operation		

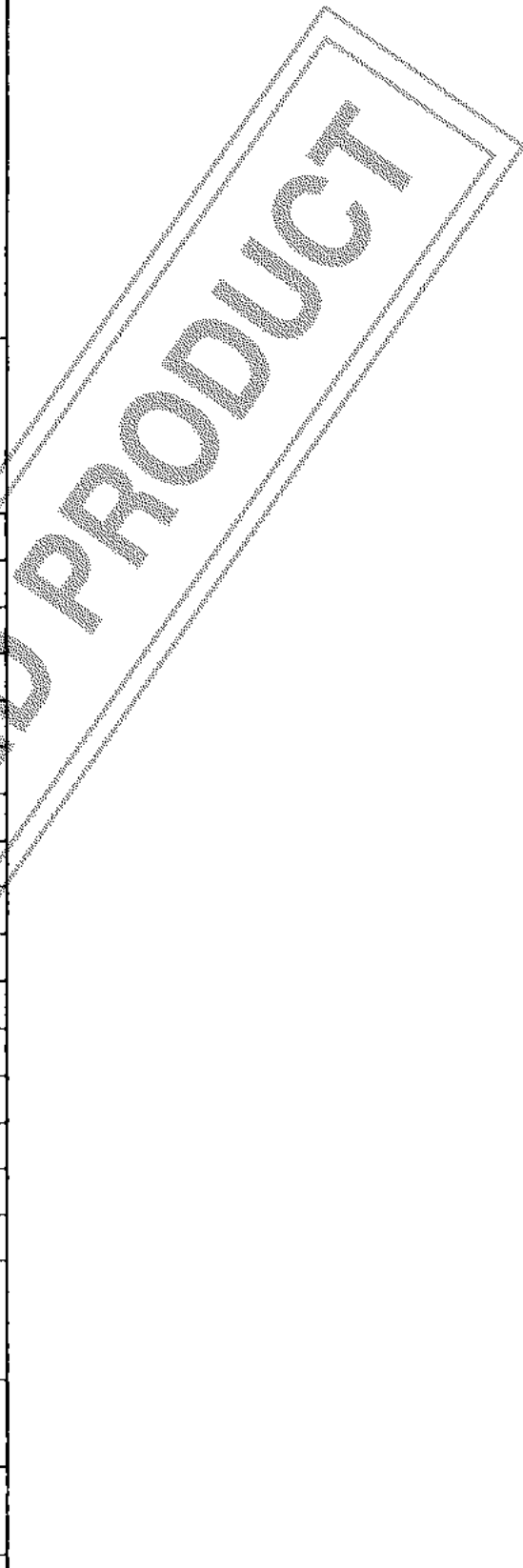

**MASK OPTIONS**

Parameter	Options
Watchdog timer (WDT)	Yes
	No
Pull-down resistors on port A (the keypad matrix input port)	Yes
	No
Instruction cycle time	2.67 $\mu$ s

Parameter	Options
Instruction cycle time	13.93 $\mu$ s
	40.00 $\mu$ s
S1 to S28 configuration	LCD driver output port
	General-purpose output port

**DEVELOPMENT SYSTEM**

The LC7232N development environment is shown in the following figure. It uses an LC72EV32 evaluation chip mounted on a TB-72EV32 target board and a

multifunctional emulator (RE32), which is controlled by a personal computer, to provide full debugging facilities.

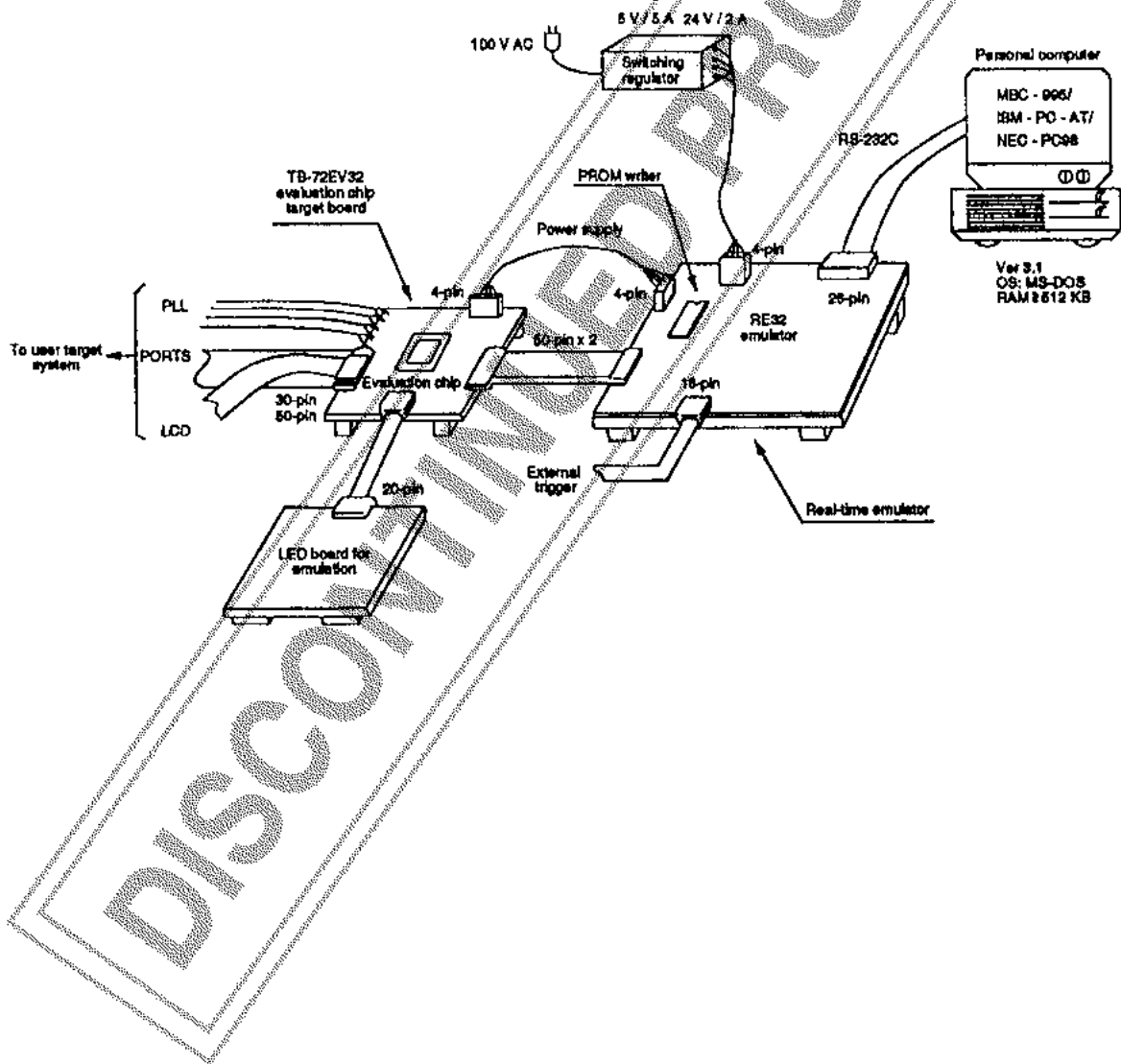

Information (including circuit diagrams and circuit parameters) herein is for example only; it is not guaranteed for volume production. SANYO believes information herein is accurate and reliable, but no guarantees are made or implied regarding its use or any infringements of intellectual property rights or other rights of third parties.